

mts

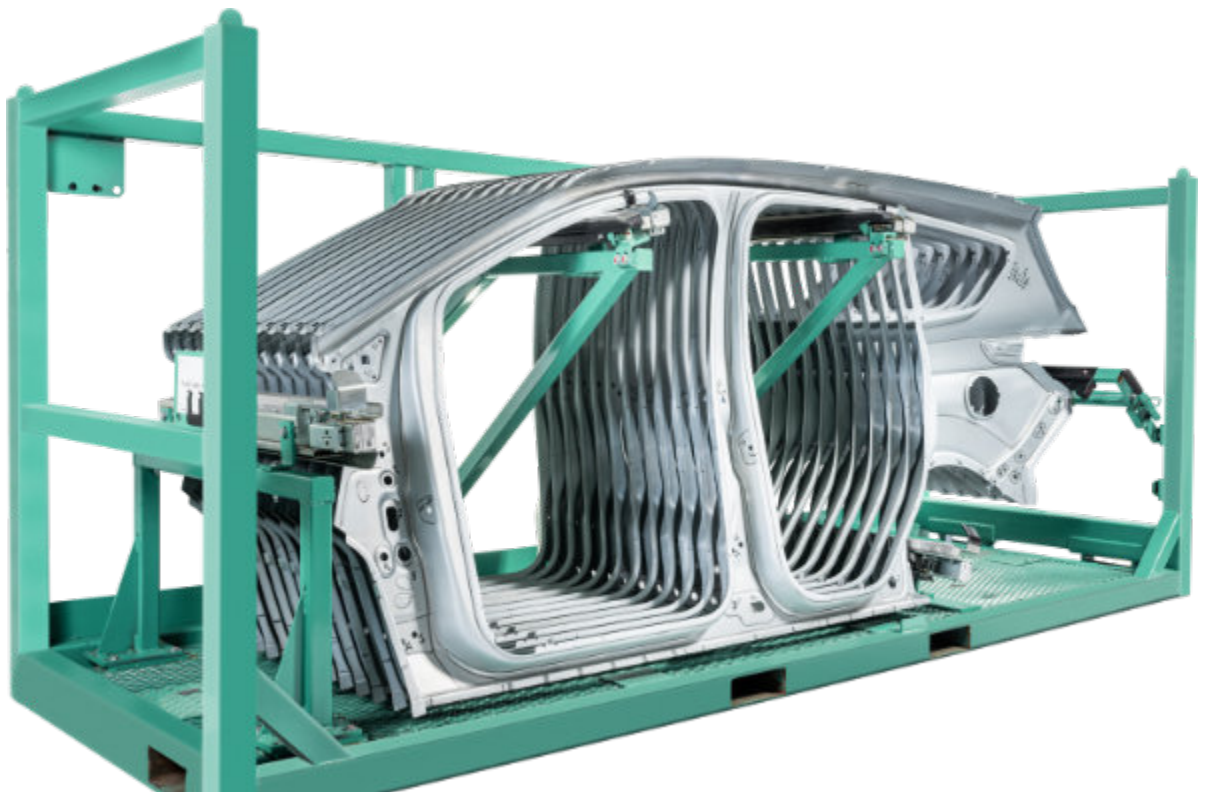

Automation ready

Load carriers for automation solutions



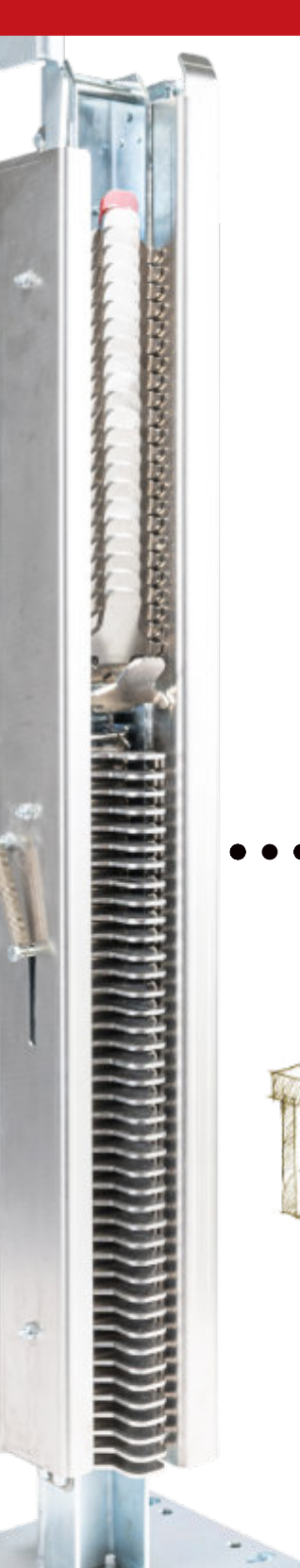

stack

Stack Towers for Highly Precise Parts.

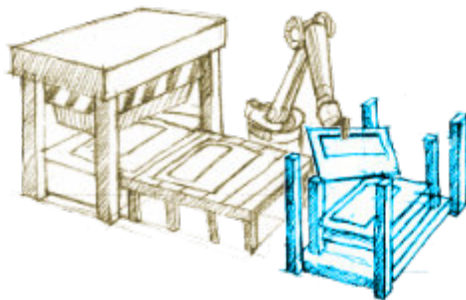

buffer

Safely Transport parts with maximum packing density.



We offer stacking systems, transport containers and feeding systems for the automation. We have extended our specialization in the secure buffering of sheet metal and machined parts as well as other materials such as glass, sensitive surfaces and modules.

mts designs the optimal solutions for your automation process to the requirements of parts placement and process. We bring stacking, gripper and centering together without positional and collision problems.

Over the entire process at your side: from brainstorming via simultaneous engineering, prototype development to series delivery. In addition, you can count on us: We work hard for you in the re-use transaction.

feed

Reliable LCA Carts for Flexible use
of the Operations.



Automation ready

Throughout your entire process
of parts handling.

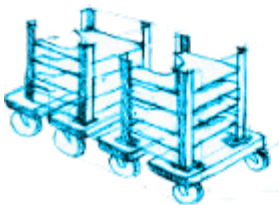
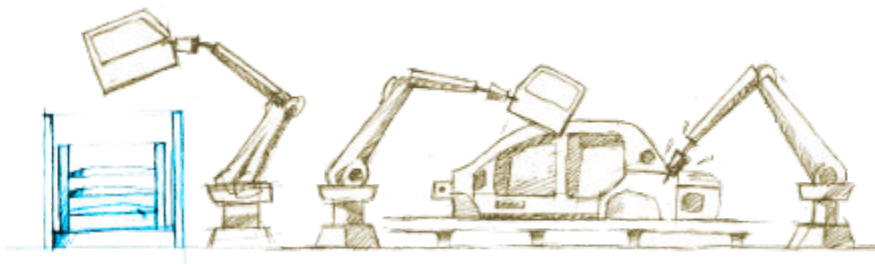
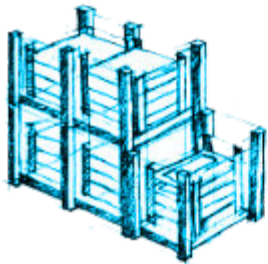



Increase Productivity



No
Production Stops



Eliminate
Damage to Parts



mts fingers hold
or clamp parts securely



Fingers
that work reliably



Part support optimized
for part and application



stack



Reduce
Transport cost



Automation ready

+40%

Up to 40% more body sides
in a rack > smallest spacing



Robotic, automatic
locking and unlocking



buffer



Cost savings



Increase
Productivity

50x

Feed up to 50x more parts
for more productivity per square meter

8h

Part buffer up to 8h
for production
Flexible use of operator



Setup in very short time
and without downtime



feed

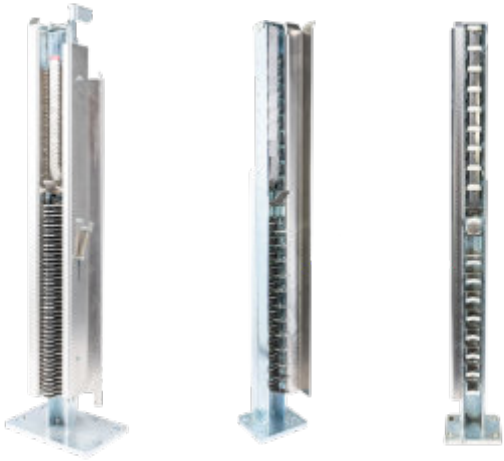

Stacking columns and part support



Parts stack



Rack



Rack with multiple stacks



Drawer cart with centering unit

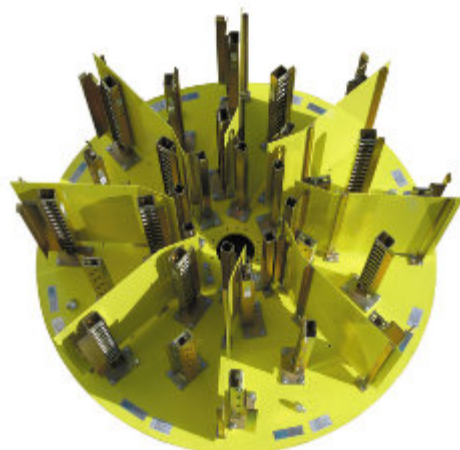

Turntable buffer

Your reliable partner in quality and on-time delivery

Since 1996 mts Maschinenbau GmbH stands for innovative products with the highest quality for stacking columns for automation applications.

Our powerful development and design department works with CATIA and Siemens NX.

With its production sites in Germany, Poland and the U.S.A. mts is able to handle large orders as a general contractor.

The mts project management team works for you to keep critical delivery dates on schedule.

Our production with a high degree of vertical integration is highly automated and meets the highest quality requirements in conjunction with our own measuring technology.





On-Time Delivery



Global
Manufacturing



Modular system
20 Designers: CATIA, UG



Prototype Build
Manufacturing Capabilities
Assembly Locations



Worldwide Partner
from Design to Prototype to Production Series



Your reliable partner. Worldwide.

mts North America

Detroit, MI, USA



mts Mengen

Mengen, Germany



mts Polska

Świebodzice, Polen



MTS NORTH AMERICA, INC.

56201 Precision Drive
Chesterfield, MI 48051

Phone: 001-586-232-4307
Fax: 001-586-232-4308

mts.us@mts-systems.com

mts Maschinenbau GmbH

Flachsstraße 10
88512 Mengen

Tel.: +49 7572 7613-0
Fax : +49 7572 7613-56

info@mts-systems.com
www.mts-systems.com

MTS POLSKA SP. Z O.O.

ul. Walbrzyska 38,
58-160 Świebodzice

mts.polska@mts-systems.com



mts-systems.com